

MOUNTING INSTRUCTION

2021-05-19 38-234200m

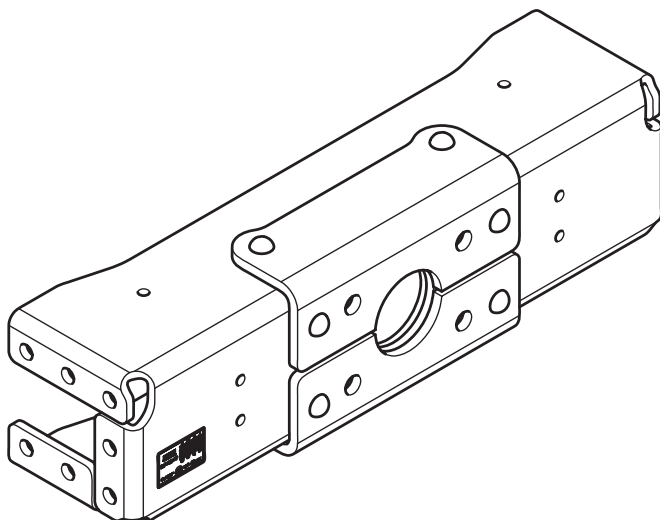

-
- | | |
|--|--|
| DE Traversen DB75V-2 und Seitenplatten | LV Vilcējspraišļa DB75V-2 un stiprinājuma plākšņu komplekts |
| DK Trækbjælke DB75V-2 og gavlsæt | NL Trekbalk DB75V-2 en zijplaten |
| EE Veotala DB75V-2 ja otsakinnituse komplektid | NO Trekkbjelke DB75V-2 og gavelsatser |
| FI Vetopalkin DB75V-2 ja sivulevyt | PL Belka zaczepowa DB75V-2 i płyty montażowe |
| FR Traverse d'attelage DB75V-2 et jeux de flasque | RU Тяговая балка DB75V-2 и фронтонные комплекты |
| GB Drawbeam DB75V-2 and End Plates | SE Dragbalk DB75V-2 och gavelsatser |



Montageanleitung
Monteringvejledning
Paigaldusjuhend
Asennusohje

Instructions de montage
Mounting instruction
Montāžas instrukcija
Montagehandleiding

Monteringsanvisning
Instrukcja montażowa
Указания по монтажу
Monteringsanvisning

DE

Allgemeines

Identifizieren Sie vor der Montage alle Teile. Montage und Wartung müssen genau und fachmännisch durchgeführt werden. Die Anweisungen und etwaigen Rahmenverstärkungen des Fahrzeugherstellers müssen beachtet werden. Übergeben Sie alle Anweisungen und Anleitungen dem Kunden, damit dieser die Unterlagen für spätere Wartung und Pflege im Fahrzeug verwahren kann. Weitere Informationen finden Sie auf unserer Homepage: www.vbg.eu.

DK

Generelt

Identificer alle dele før montering. Montering og service skal udføres omhyggeligt og på en faglig korrekt måde. Bemærk at der skal tages hensyn til bilfabrikantens vejledninger og eventuelle ramme-forstærkninger. Giv kunden alle anvisninger og instruktioner, så de kan opbevares i bilen med henblik på fremtidig service og vedligeholdelse. Yderligere information findes på vores hjemmeside www.vbg.eu.

EE

Üldist

Identifitseerige enne montaaži kõik osad. Paigaldus ja hooldus tuleb teostada hoolikalt ja professionaalselt. Pange tähele, et arvesse tuleb võtta ka sõiduki tootja juhiseid ja võimalikke ettekirjutusi raamitugevduste osas. Andke juhi käsiraamat kliendile kaasa sõidukis säilitamiseks, et see oleks käepärast hilisemate hoolduste korral. Täiendava teabe saamiseks külastage meie kodulehte www.vbg.eu.

FI

Yleistä

Tarkasta kaikki osat ennen asennusta. Asennus ja huolto tulee tehdä huolellisesti ja ammattitaidolla. Huomioi ajoneuvon valmistajan ohjeet asennuksesta ja mahdollisista vahvistuksista. Luovuta kaikki ohjeet asiakkaalle ajoneuvossa säilytettäväksi tulevia huoltoja ja kunnossapitoa varten. Lisätietoja löytyy kotisivuiltamme www.vbg.eu.

FR

Généralités

Identifier toutes les pièces avant le montage. Le montage et l'entretien doivent être effectués avec le plus grand soin et selon les instructions recommandées. Observer que les instructions du constructeur du véhicule et les éventuels renforts du cadre doivent impérativement être respectés. Remettre toute la documentation au client. Elle doit être conservée dans le véhicule pour les entretiens et maintenances ultérieurs. Pour plus d'informations, consultez notre site Web www.vbg.eu.

GB

General

Identify all parts before installation. Installation shall be done in a proper and competent manner. The truck manufacturer's body building instructions must be observed. All directives and instructions should be kept in the vehicle for future service and maintenance. For more information, go to our website: www.vbg.eu.

LV

Vispārēja informācija

Pirms uzstādīšanas identificējiet visas detaļas. Uzstādīšana veicama rūpīgi un kompetenti. Jāievēro kravas automašīnas ražotāja korpusa montāžas instrukcijas. Visus norādījumus un instrukcijas, kas būs nepieciešamas servisam un apkopei, nododiet klientam, lai tās tiktu uzglabātas transporta līdzeklī. Lai saņemtu vairāk informācijas, skatiet mūsu mājaslapu www.vbg.eu.

NL

Algemeen

Voor de montage moet u alle onderdelen identificeren. Voer montage en service zorgvuldig en deskundig uit. Let op dat rekening moet worden gehouden met de aanwijzingen van de voertuigfabrikant en eventuele chassisverstevingen. Laat de klant alle aanwijzingen en instructies in het voertuig bewaren, zodat deze voor toekomstige service en onderhoud beschikbaar zijn. Ga voor meer informatie naar onze website www.vbg.eu.

NO

Generelt

Identifiser alle deler før montering. Montering og service skal utføres nøyaktig og fagmessig. Observer at det må tas hensyn til kjøretøyproduzentens anvisninger og eventuelle rammeforsterkninger. Overlever alle anvisninger og instruksjoner til kunden for oppbevaring i kjøretøyet for fremtidig service og vedlikehold. Gå til hjemmesiden vår, www.vbg.eu, for mer informasjon.

PL

Informacje ogólne

Zapoznaj się z poszczególnymi częściami przed przystąpieniem do montażu. Czynności montażowe i serwisowe należy wykonywać dokładnie i fachowo. Zauważ, że konieczne jest stosowanie się do instrukcji producenta pojazdu oraz uwzględnienie ewentualnych wzmocnień ramy. Wszystkie wskazówki i instrukcje należy przekazać klientowi w celu przechowywania ich w pojeździe do wykorzystania przy okazji przyszłych czynności serwisowych i konserwacyjnych. Dodatkowe informacje znajdują się na naszych stronach internetowych www.vbg.eu.

RU

Общая информация

Перед монтажом, проверьте наличие всех деталей. Монтаж и обслуживание должны осуществляться тщательно и профессионально. Заметьте, что должны учитываться и приниматься во внимание возможные усиления рамы, сделанные изготовителем транспортного средства. Передайте клиенту все указания и инструкции для хранения их в машине для обслуживания и сервисных работ в будущем. Для получения дополнительной информации, посетите наш веб-сайт www.vbg.eu.

SE

Allmänt

Identifiera alla delar före montering. Montering och service skall utföras noggrant och fackmannamässigt. Notera att fordonstillverkarens anvisningar och eventuella ramförstärkningar måste beaktas. Lämna alla anvisningar och instruktioner till kunden att förvaras i fordonet för framtida service och underhåll. För mer information, gå in på vår hemsida www.vbg.eu.

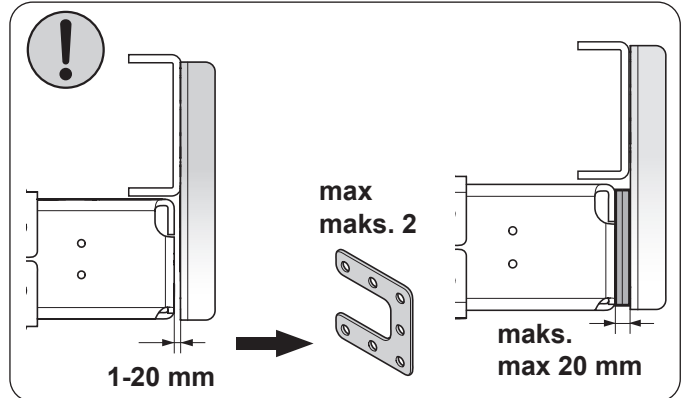
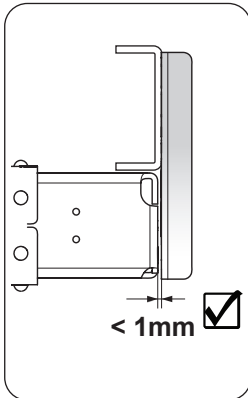
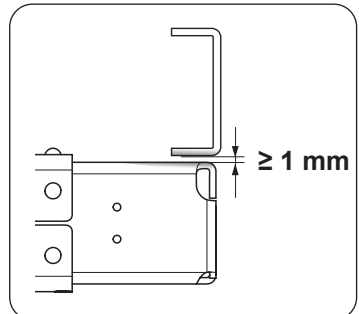
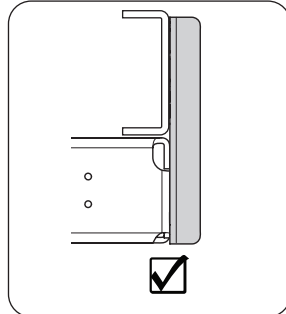
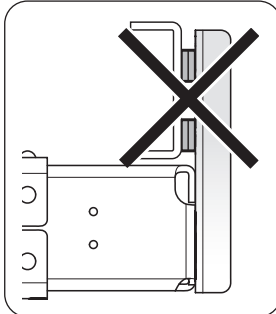
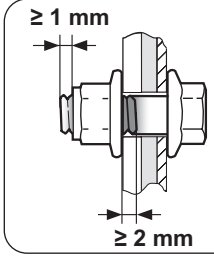
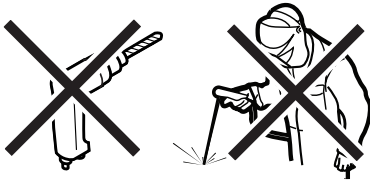
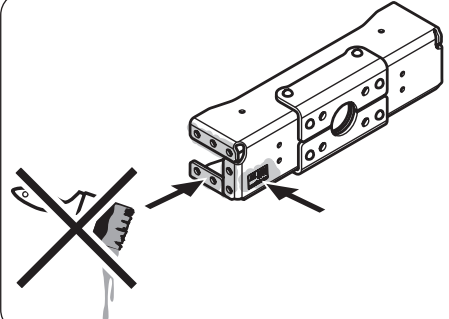
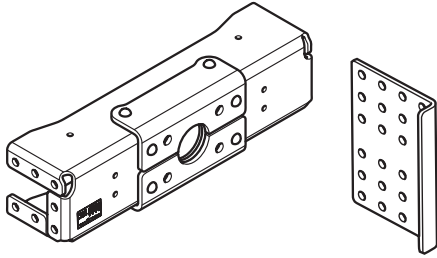

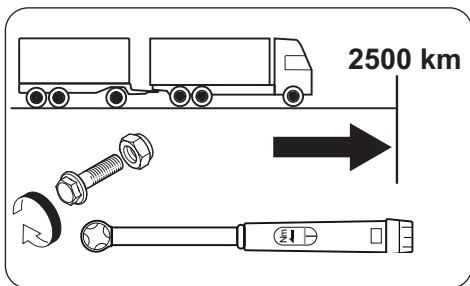
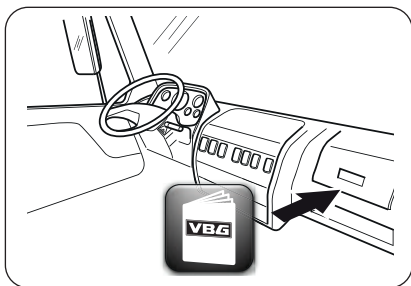

DB 75V-2	6
EDH-2	7
EDH-2V	8
EDU-2	9
EDHZ	10
EDMS-2	12
EDH-3/EDHU	13
EDM-2	20
EDL-2	25
EDM-3	30



DB75V-2

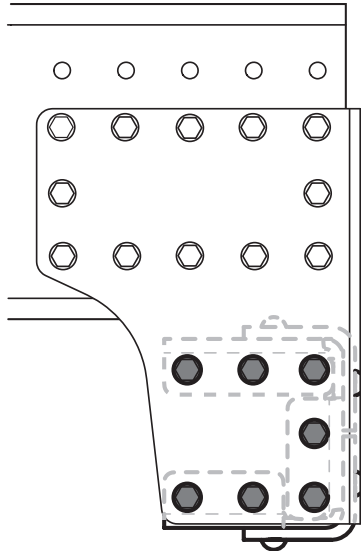
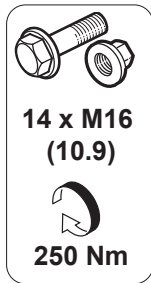
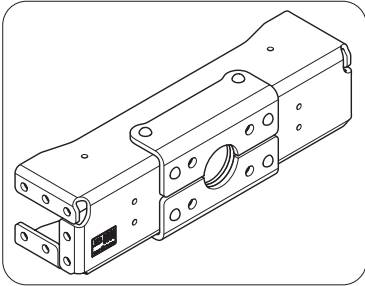



EDH-2

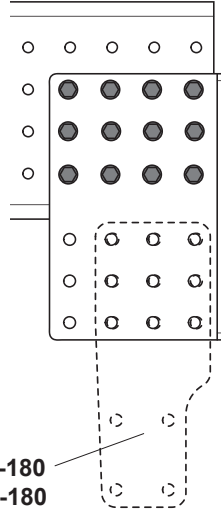
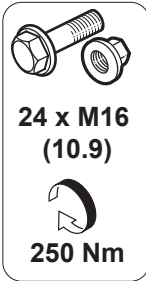
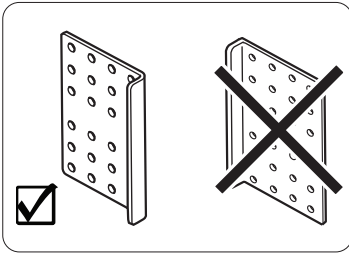

EUP-180
EUR-180

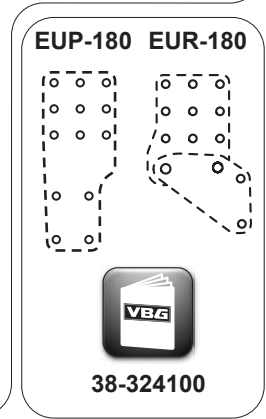

DB75V-2

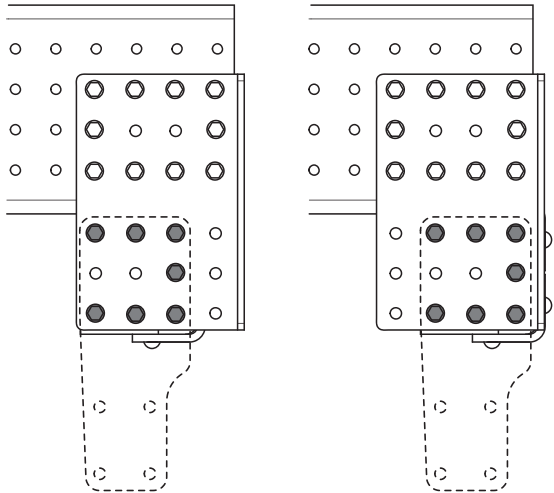
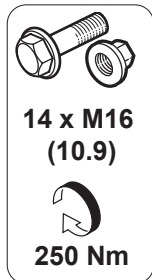
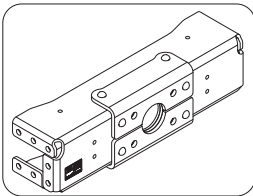



EDH-2V

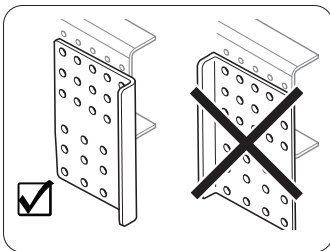

EDH-2V + EUP-180
EDH-2V+ EUR-180



30 x M14 (10.9)

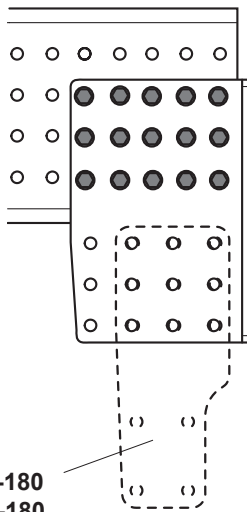
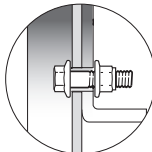
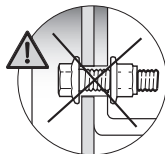

EUP-180
EUR-180

EDH-2V



30 x M14
(10.9)



163 Nm

EUP-180 EUR-180

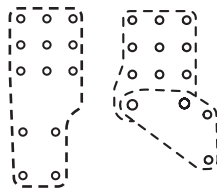

38-324100

DB75V-2

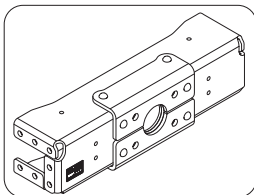

14 x M16
(10.9)



250 Nm

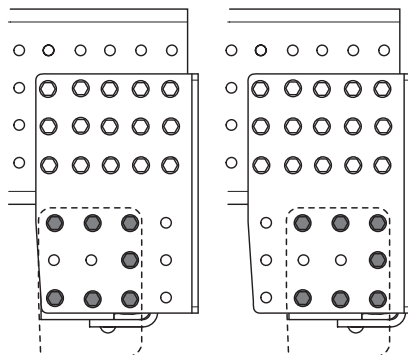



EDU-2

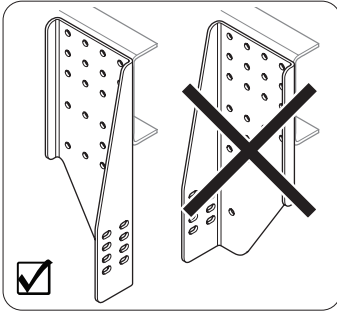

**20 x M16
(10.9)**



250 Nm

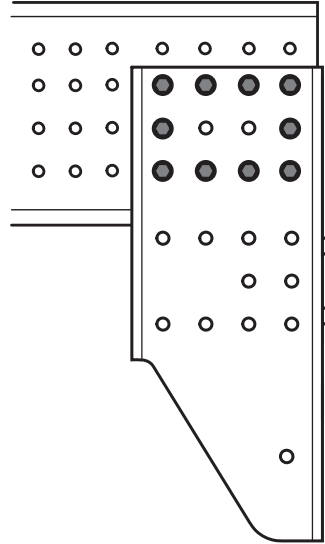

DB75V-2

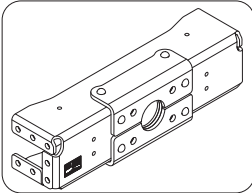

**14 x M16
(10.9)**



250 Nm

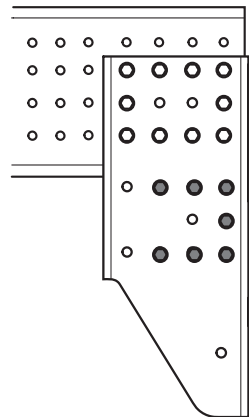
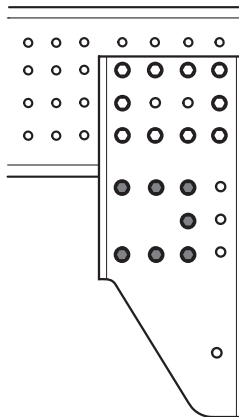



EDHZ

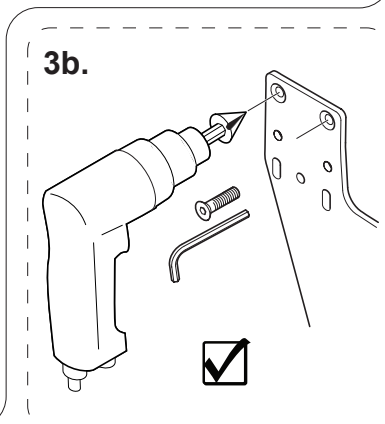
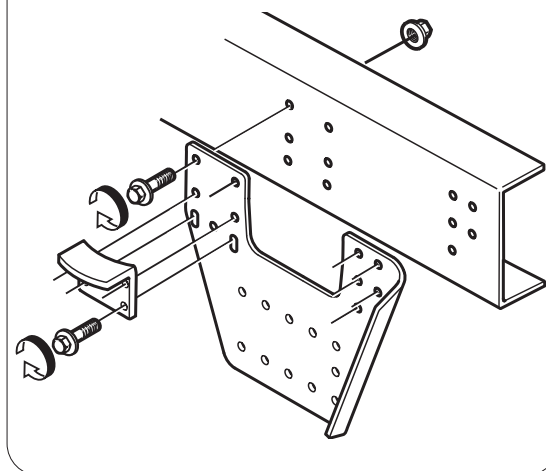
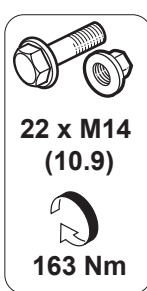
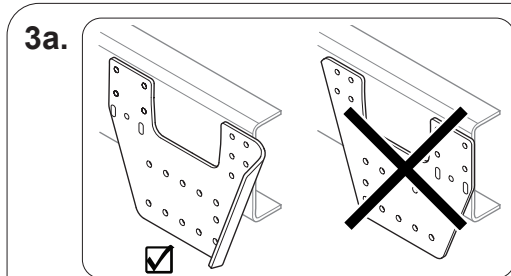
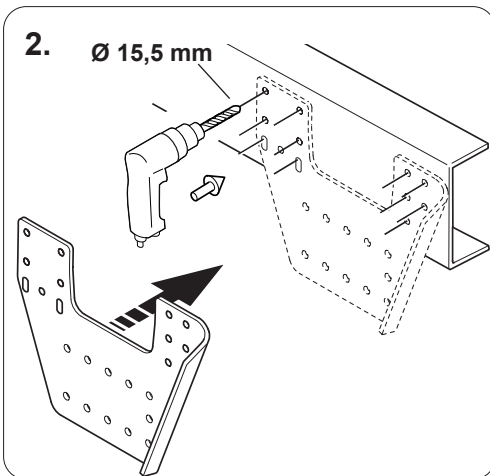
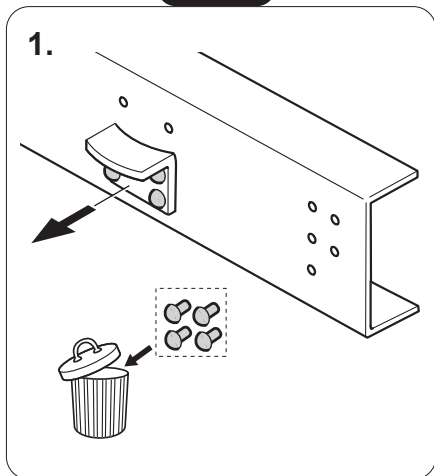

DB75V-2

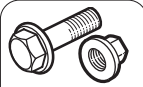
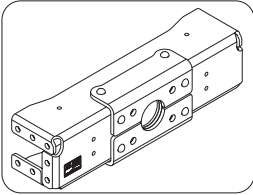

**14 x M16
(10.9)**



250 Nm

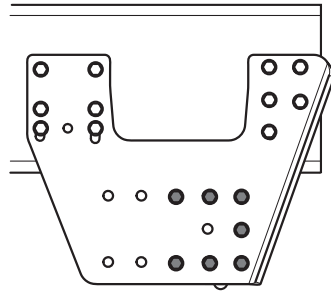
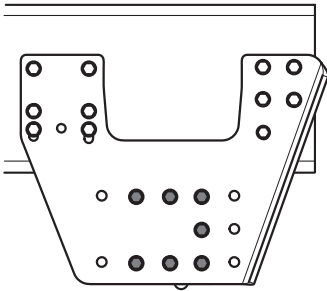



EDMS-2

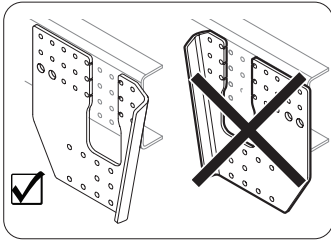

**38 x M14
(10.9)**



163 Nm

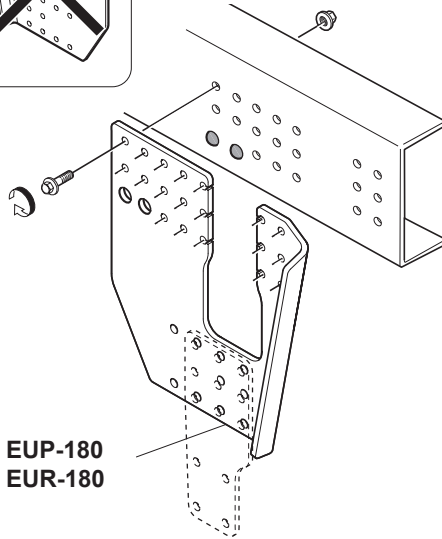

**EUP-180
EUR-180**

EUP-180 EUR-180

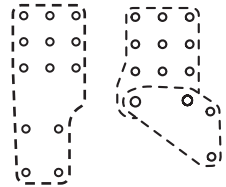

38-324100

DB75V-2

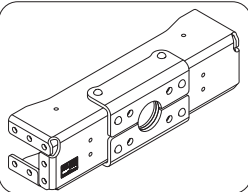

**14 x M16
(10.9)**



250 Nm

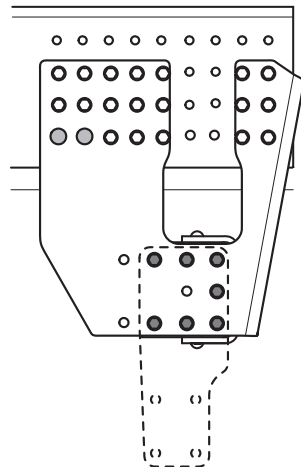
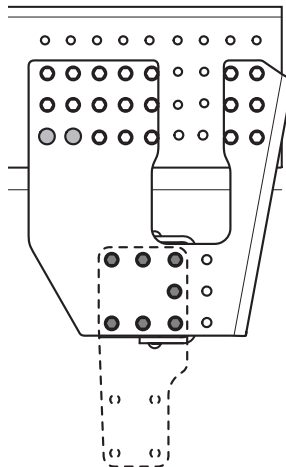



EDH-3 DAF

EDHU DAF

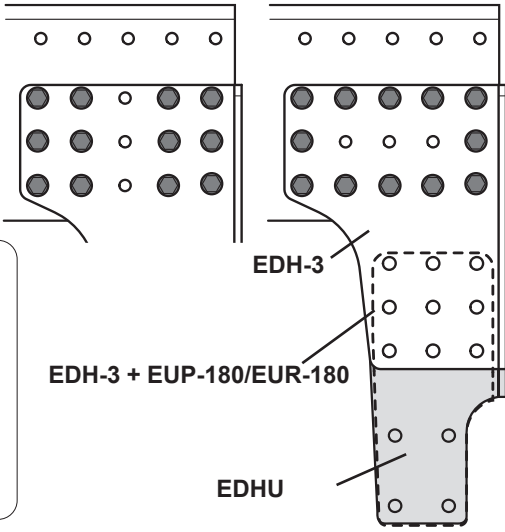
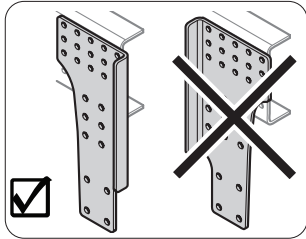
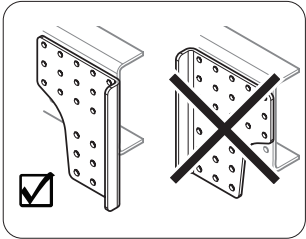

EUP-180 EUR-180

VBG

38-324100

DB75V-2

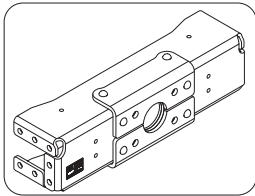

14 x M16 (10.9)

250 Nm

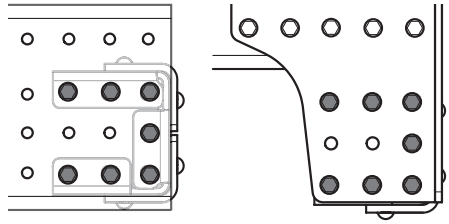



EDH-3 Scania

EDHU Scania

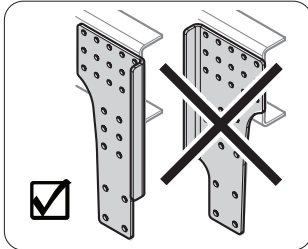
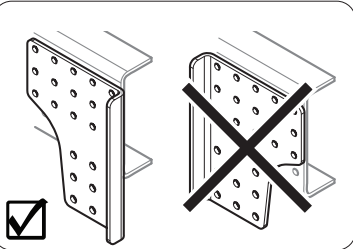

EDH-3



**24 x M14
(10.9)**



163 Nm

EDH-3 + EUP-180/ EUR-180 EDHU



24 x M14 (10.9)



163 Nm

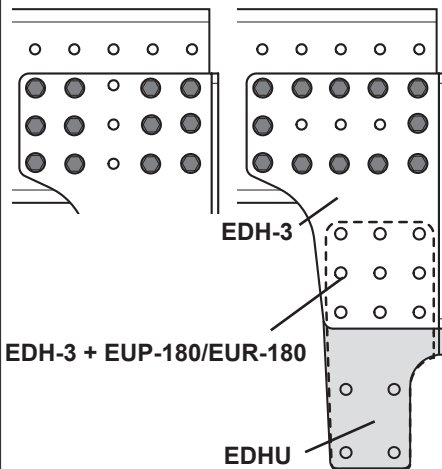
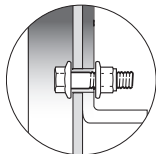
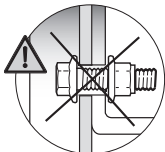

EUP-180 EUR-180

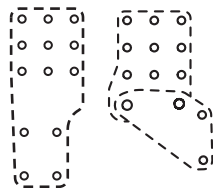

38-324100

DB75V-2

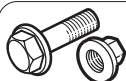
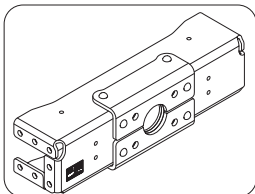

**14 x M16
(10.9)**



250 Nm

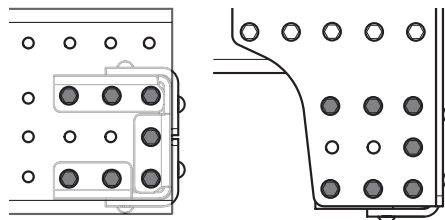



EDH-3 Volvo

EDHU Volvo

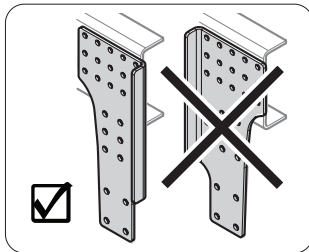
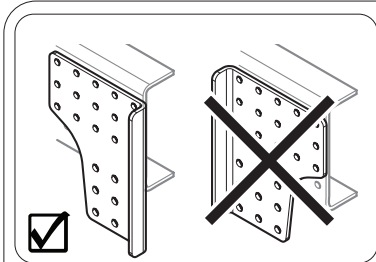

EDH-3



24 x M14
(10.9)



163 Nm

EDH-3
+
EUP-180



24xM14
(10.9)



163 Nm

EDHU



24xM14
(10.9)



163 Nm

24xM16
(10.9)



250 Nm

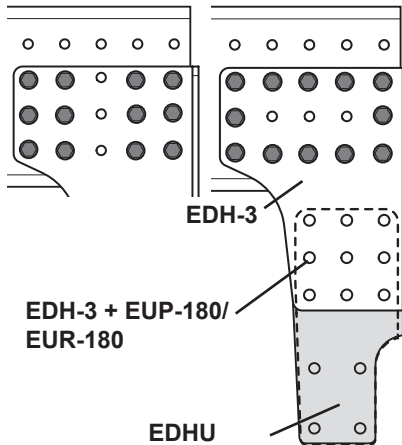
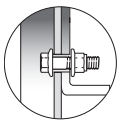
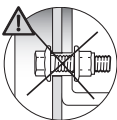

EUP-180 EUR-180

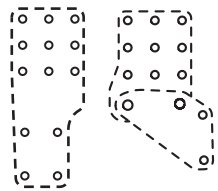

38-324100

DB75V-2

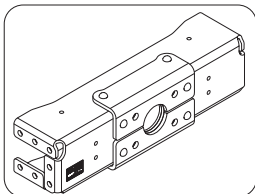

14 x M16
(10.9)



250 Nm

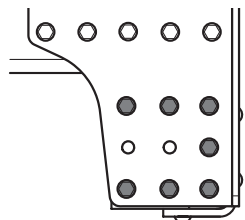
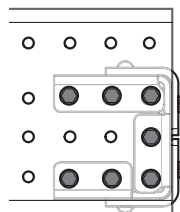



EDH-3 Iveco

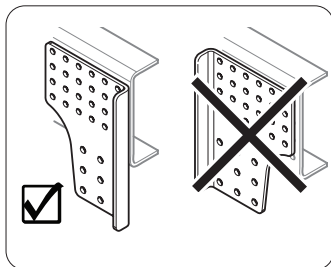

EDHU Iveco

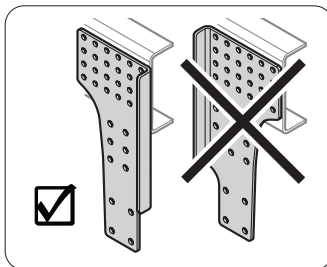

EDH-3

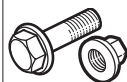

24 x M14
(10.9)



163 Nm

EDH-3 + EUP-180/ EUR-180 EDHU

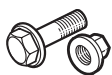

24 x M14 (10.9)



163 Nm

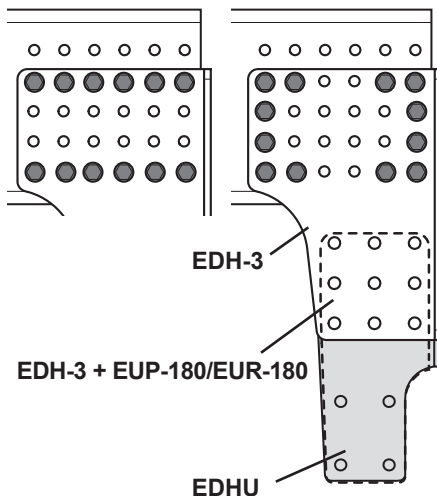
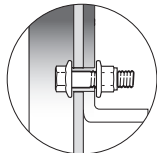
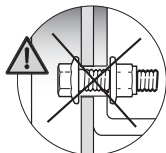

EUP-180 EUR-180

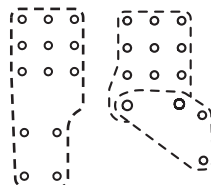

38-324100

DB75V-2

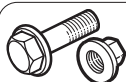
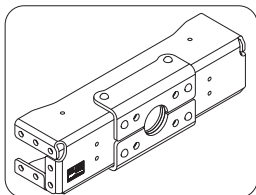

14 x M16
(10.9)



250 Nm

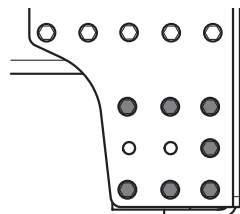
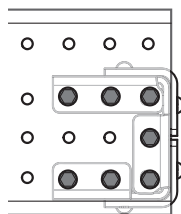



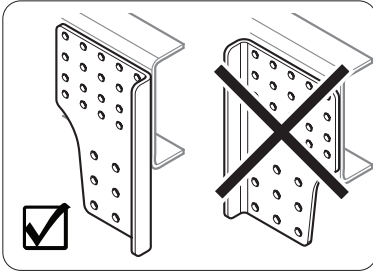

EDH-3 MB 50x45



EDH-3



**24 x M14
(10.9)**



163 Nm

EDH-3 + EUP-180



24 x M14 (10.9)



163 Nm

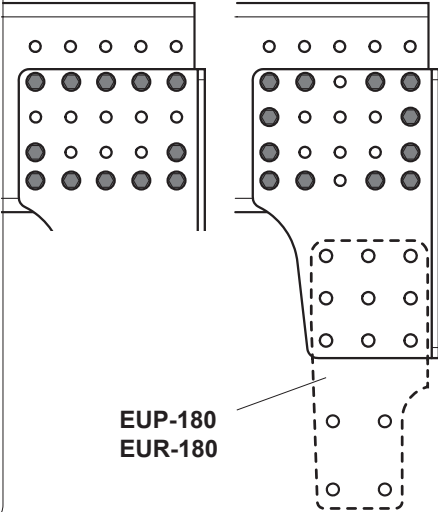
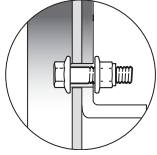
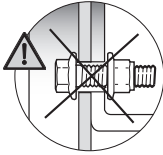

EUP-180 EUR-180

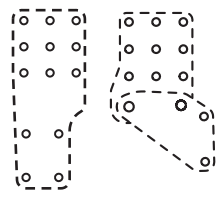

38-324100

DB75V-2

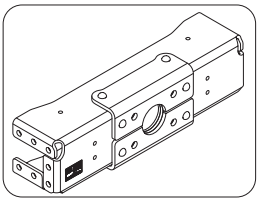

**14 x M16
(10.9)**



250 Nm

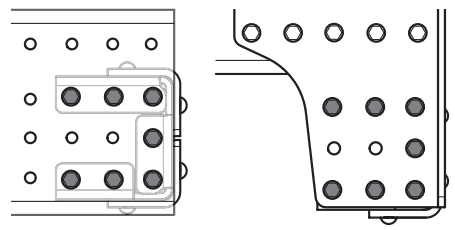



EDH-3 MAN

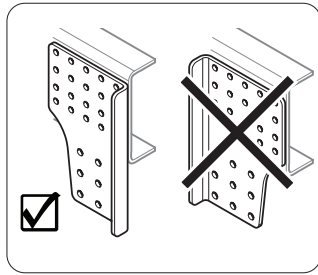

EDHU MAN

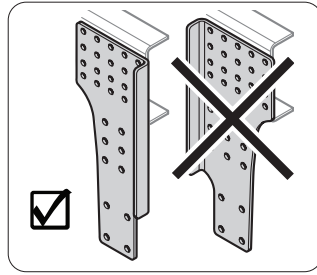

EDH-3



24 x M14
(10.9)



163 Nm

EDH-3 + EUP-180/ EUR-180 EDHU



24 x M14 (10.9)



163 Nm

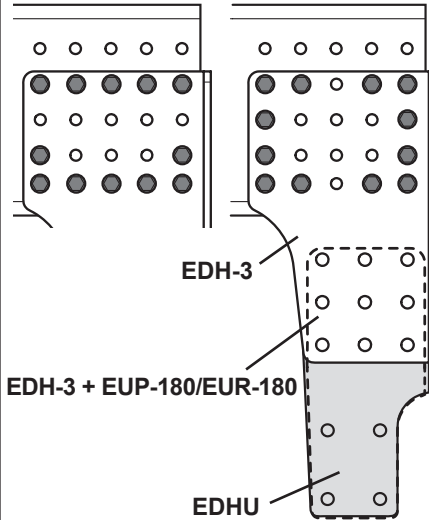
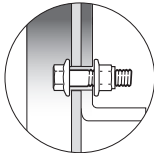
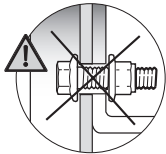

EUP-180 EUR-180

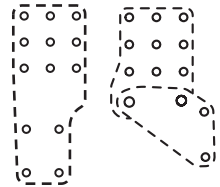

38-324100

DB75V-2

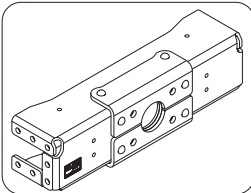

14 x M16
(10.9)



250 Nm

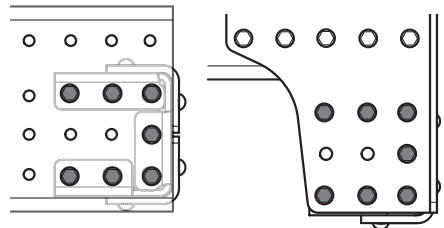



EDH-3 MB 50x50

EDHU MB



20 x M16
(10.9)



250 Nm

MBN 10105

MBN 13023

20 x M16 (10.9)



225 Nm

+

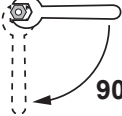

90°

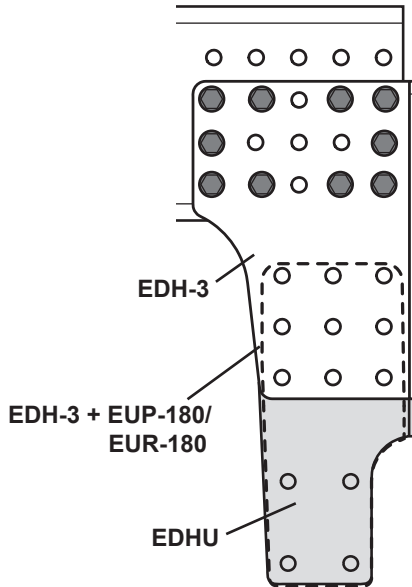
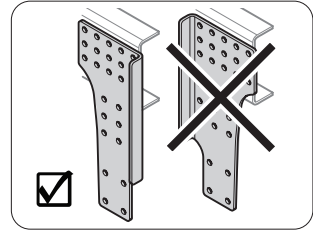
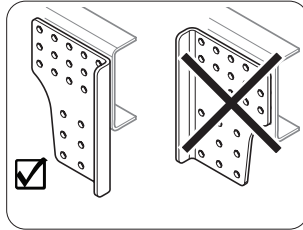

EUP-180 EUR-180

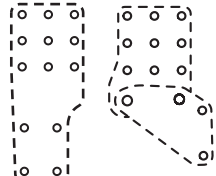

38-324100

DB75V-2

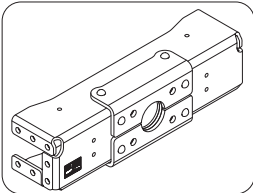

14 x M16
(10.9)



250 Nm

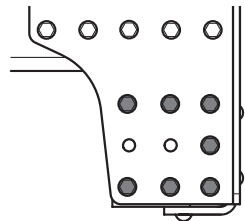
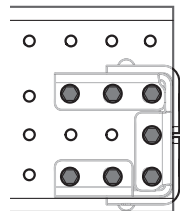



EDM-2 DAF

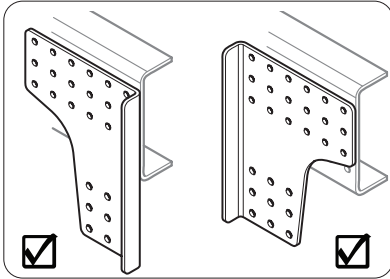

**20 x M16
(10.9)**



250 Nm

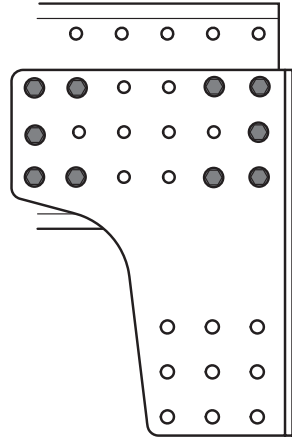

DB75V-2

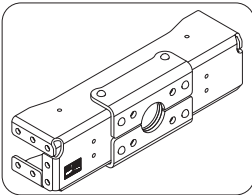

**14 x M16
(10.9)**



250 Nm

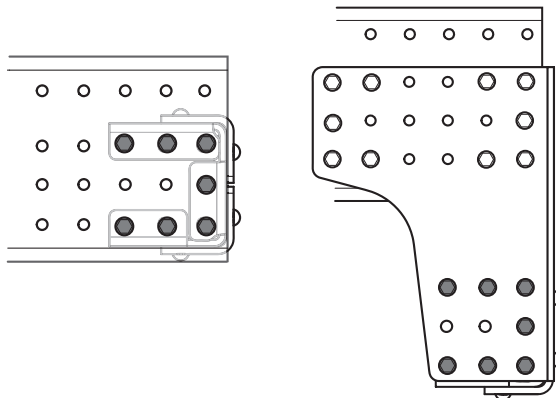



EDM-2 Scania

EDM-2 Volvo

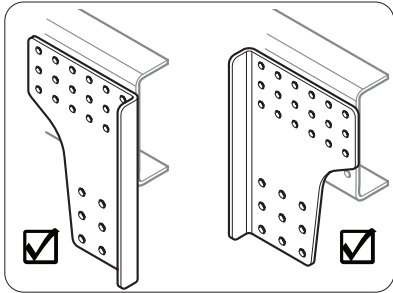

**24 x M14
(10.9)**



163 Nm

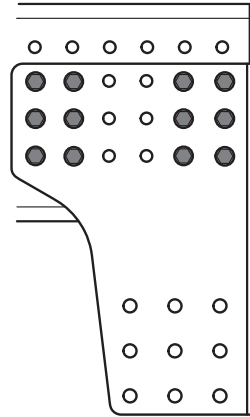

DB75V-2

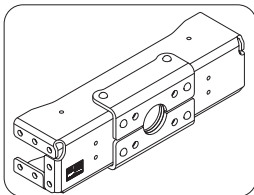

**14 x M16
(10.9)**



250 Nm

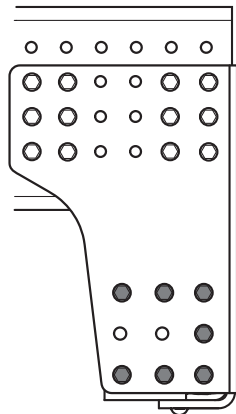



EDM-2 Iveco

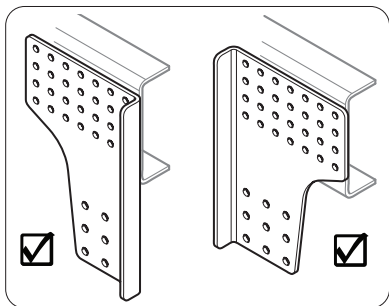

**24/28 x M14
(10.9)**



163 Nm

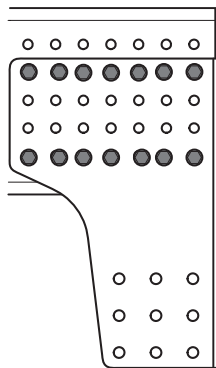
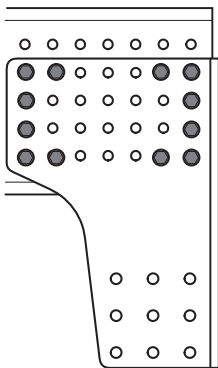

DB75V-2

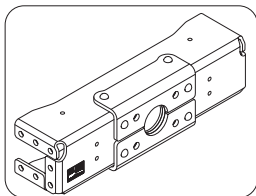

**14 x M16
(10.9)**



250 Nm

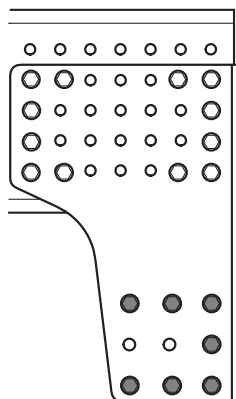



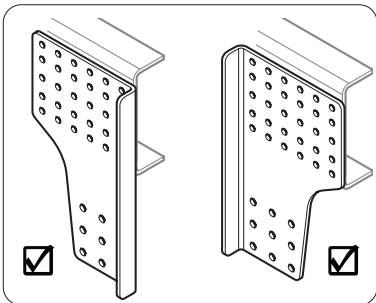

EDM-2 MAN

EDM-2 MB 50x45





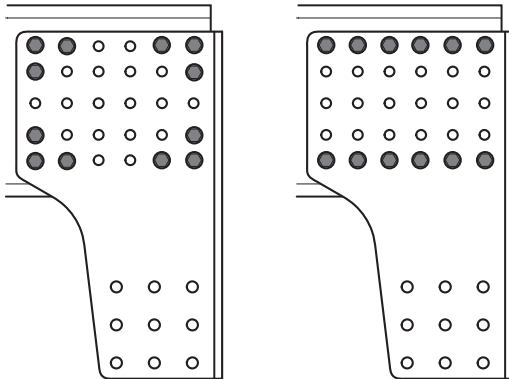

**24 x M14
(10.9)**

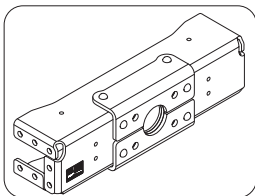
163 Nm



DB75V-2

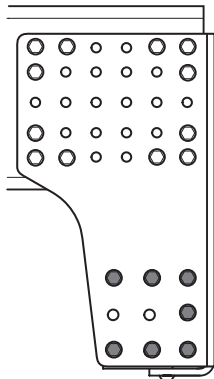



**14 x M16
(10.9)**

250 Nm



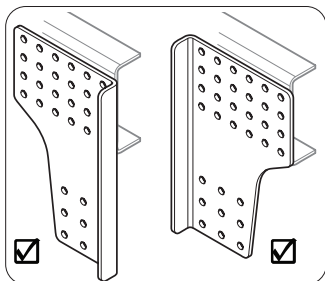

EDM-2 MB 50x50



 **MBN 10105**

 **MBN 13023**

20 x M16 (10.9)

225 Nm

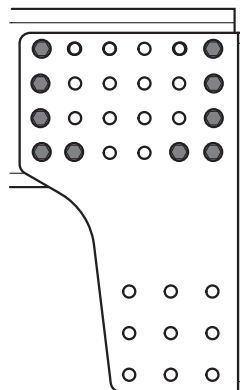
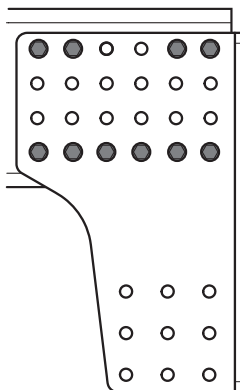
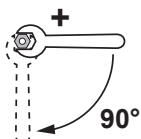

DB75V-2

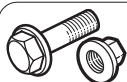
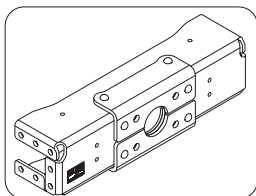

**14 x M16
(10.9)**



250 Nm

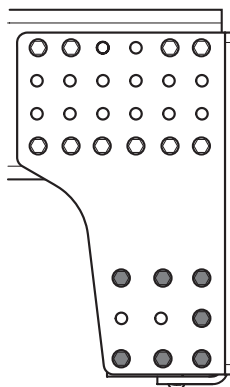



EDL-2 DAF

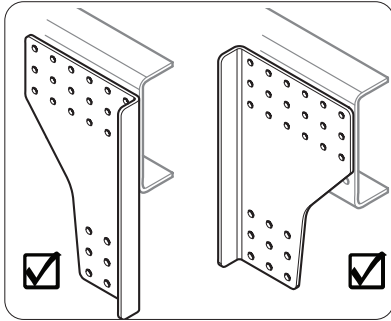

**28 x M16
(10.9)**



250 Nm

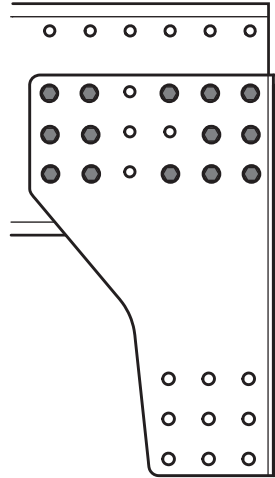

DB75V-2

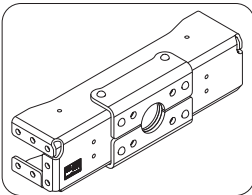

**14 x M16
(10.9)**



250 Nm

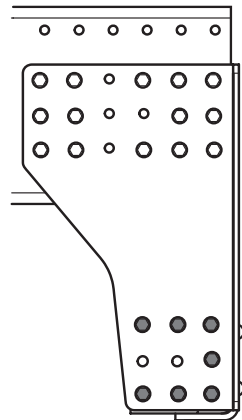
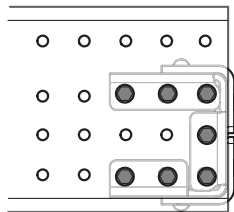

EDL-2 Scania

EDL-2 Volvo

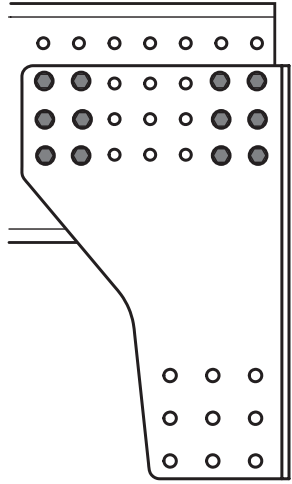
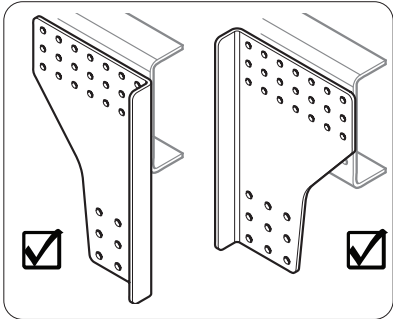

**24 x M14
(10.9)**



163 Nm

DB75V-2

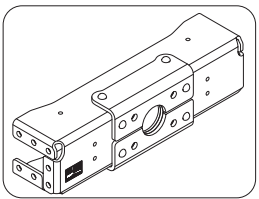

**14 x M16
(10.9)**



250 Nm

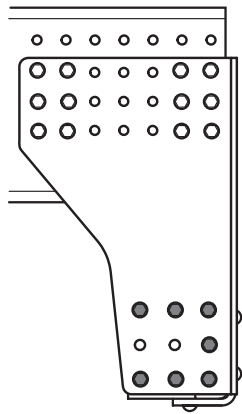



EDL-2 Iveco

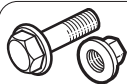
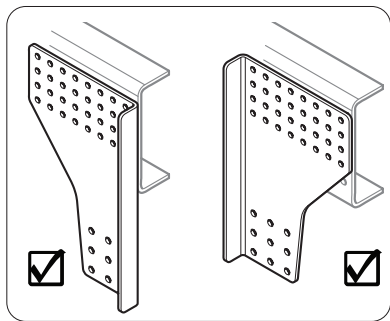

**24 x M14
(10.9)**



163 Nm

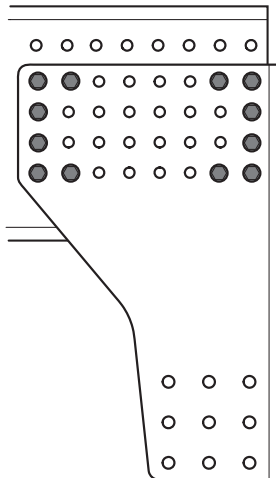

DB75V-2

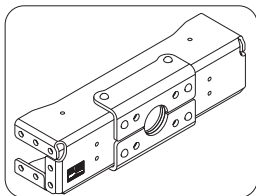

**14 x M16
(10.9)**



250 Nm

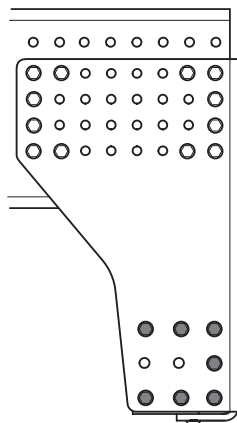



EDL-2 MAN

EDL-2 MB 50x45

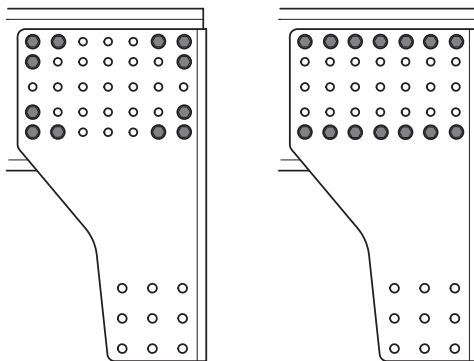
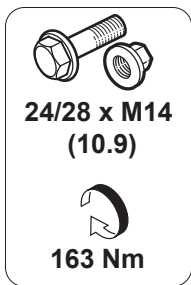
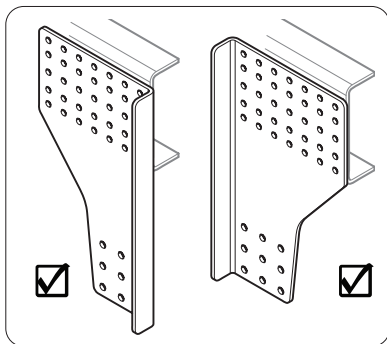

DB75V-2

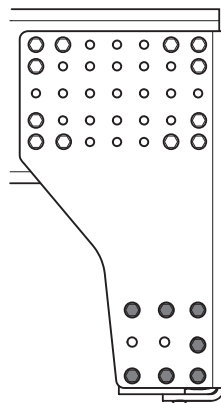
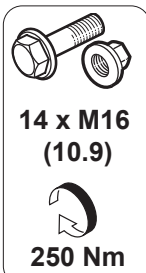
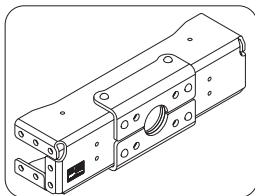



EDL-2 MB 50x50

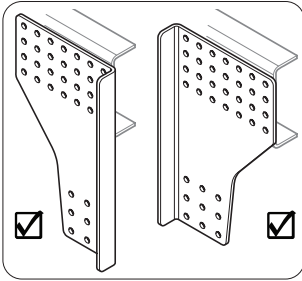

 **MBN 10105**

 **MBN 13023**

20 x M16 (10.9)



225 Nm

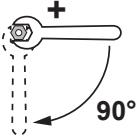

90°

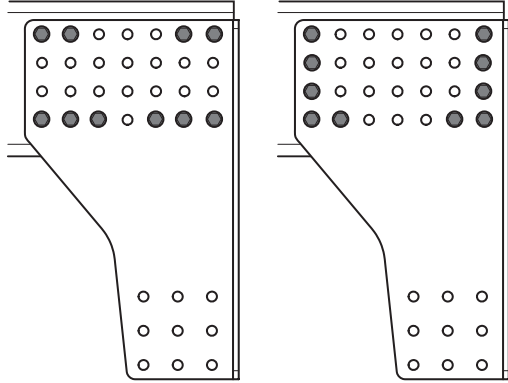

DB75V-2

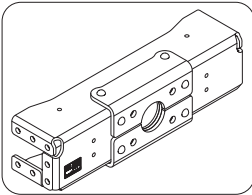

**14 x M16
(10.9)**



250 Nm

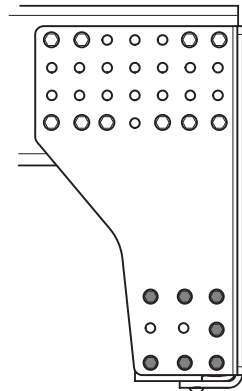



EDM-3

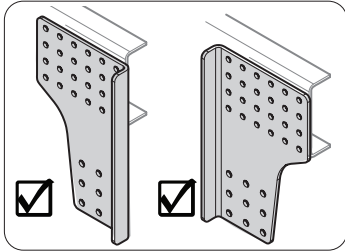

MB

MBN 10105

MBN 13023

24 x M16 (10.9)



225 Nm

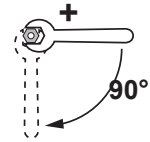

EDM-3 + EUP-180



24 x M14 (10.9)

163 Nm

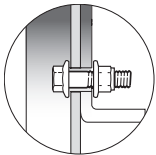
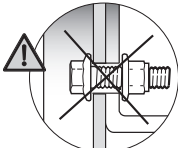

EDM-3



24 x M14
(10.9)

163 Nm

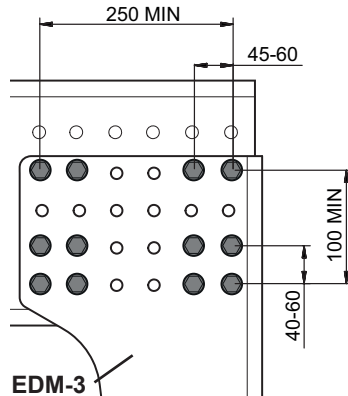

EDM-3

EDM-3



24 x M16
(10.9)

250 Nm

EDM-3 + EUP-180/EUR-180

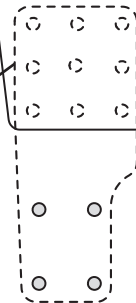

EUP-180 EUR-180

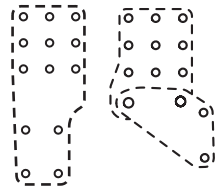

38-324100

Member of VBG Group

www.vbg.eu



The strong connection